

86IRL - CS001 - ROOF RACK

FITTING FOR:

PEUGEOT PARTNER 2018+ SWB (L1)



INSTALLATION INSTRUCTIONS

ATTENTION!

- Check the box before installation.
- Read the guide before installation for your safety and making complete installation.
- Make the installation according to the installation guide otherwise, our company has no responsibility for any damage.
- If you any have questions please contact our company.

INSTALLATION OF CROSS PROFILES



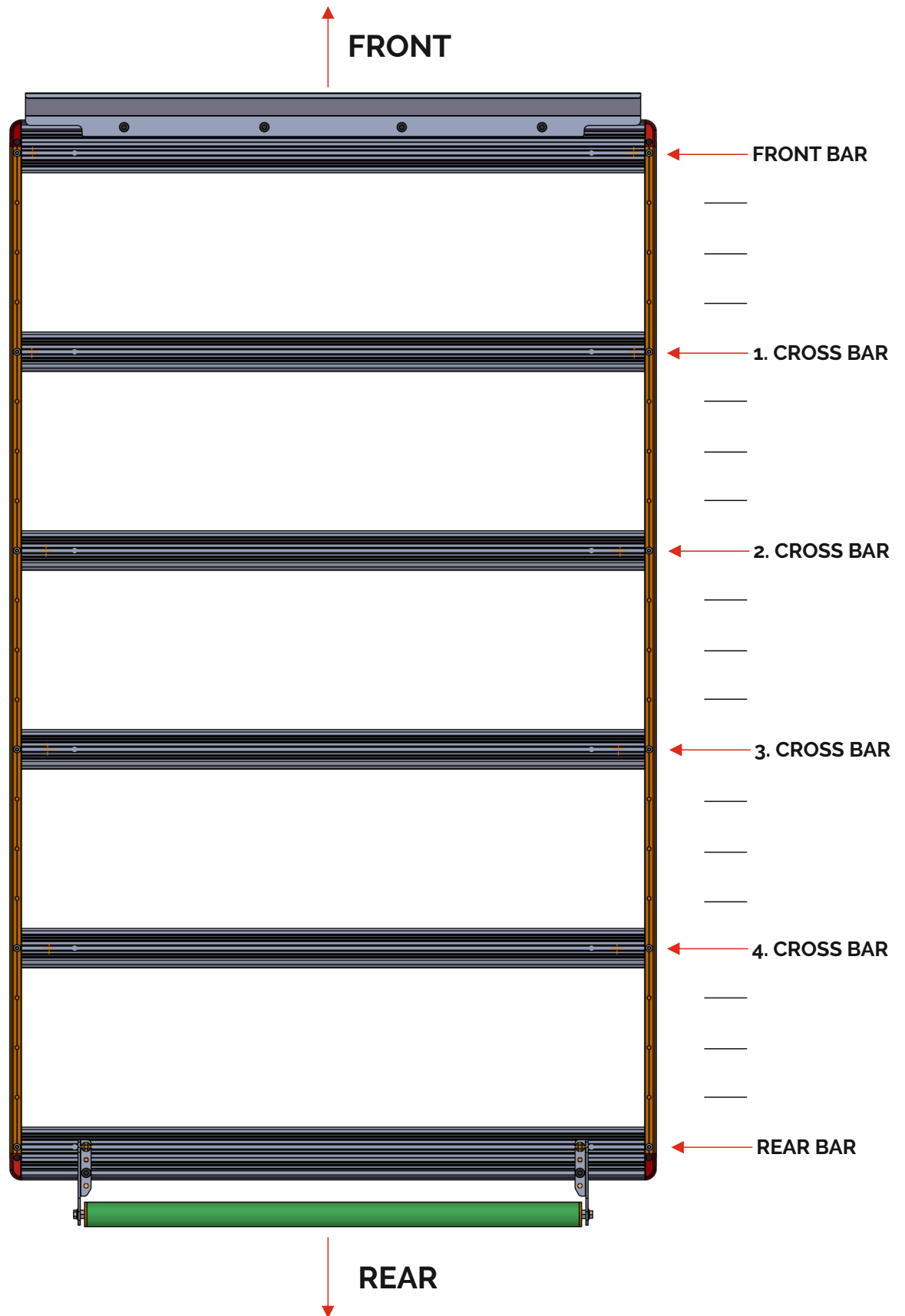



WARNING: THIS PROCESS WILL BE MADE BEFORE 5TH STEP IN THE PRODUCT GUIDE.

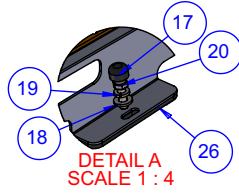
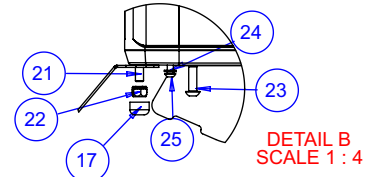
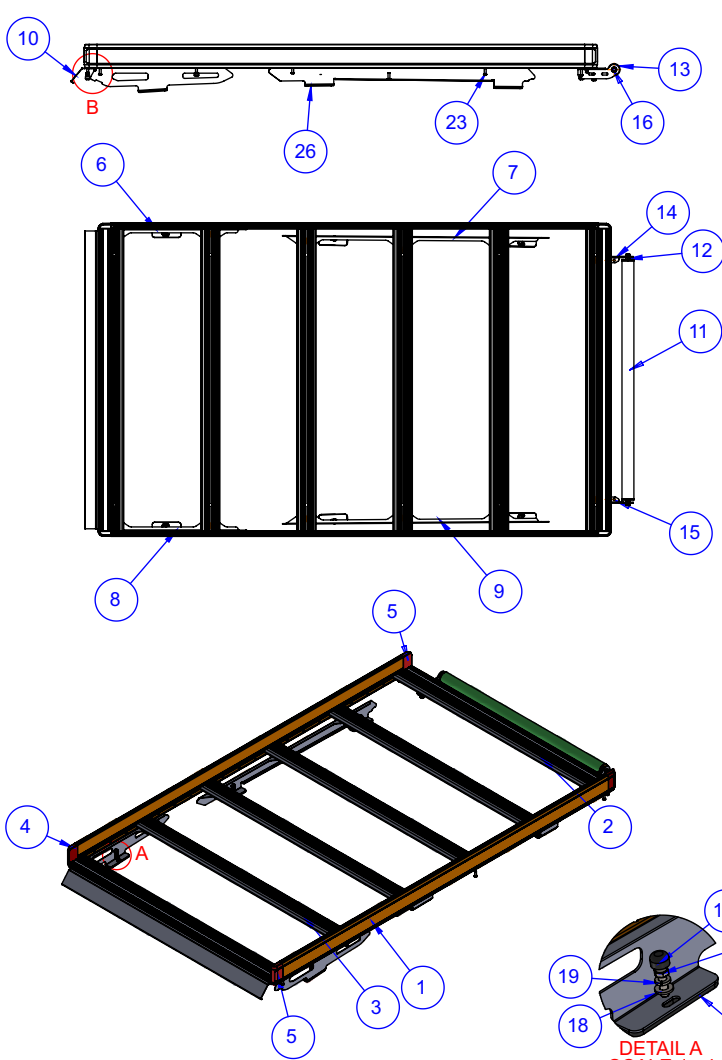

CROSS PROFILES WILL BE MOUNTED AS SHOWN ON FIGURE ABOVE.

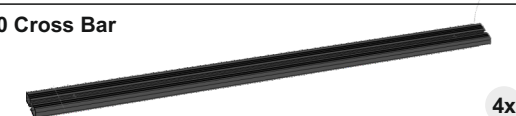
NECESSARY MATERIALS



- L20 Side Bar**
01  2x
- H30 Front Bar**
02  2x
- W30 Cross Bar**
03  4x
- 04  **C5-AK1--1 Cap Right** 2x
- 05  **C5-AK1--2 Cap Left** 2x
- 10  **S8-T25 Aluminium spoiler** 1x
- 11  **Roller R01 1000 mm** 1x

Roller Bracket Right

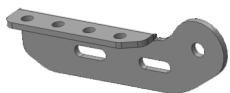

14 1x

Roller Bracket Left

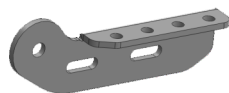

15 1x

M10X20 AKB Bolt



16 2x

M8 Bolt's Cab

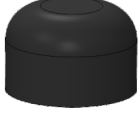

17 24x

M8 Wide Washer



18 6x

M8 Spring Washer



19 6x

M8X25 AKB Bolt



20 6x

M8X20 AKB Bolt



21 18x

M8 Lock Nut



22 18x

M8X25 Allen Bolt



23 12x

M6 Spring Washer



24 4x

M6X16 Allen Bolt



25 4x

KC5128 Rubber



26 6x

5127200F0 PSFB



6 1x

5127200B0 PSRB

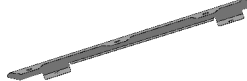

7 1x

5127200F0 DSFB



8 1x

5127200B0 DSRB



9 1x

Sista Silicon



27 1x

NECESSARY TOOLS

Allen Key 5 mm
Spanner 13 mm
Meter

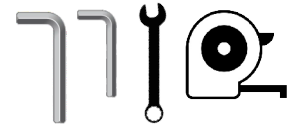

ITEM NO.	PART NUMBER	DESCRIPTION	QTY.
1	L20	Side Bar	2
2	H30	Front Bar	2
3	W30	Cros Bar	4
4	C5-AK1--1	Right	2
5	C5-AK1--2	Left	2
6	5127200F0	Passenger Side Front Bracket	1
7	5127200B0	Passenger Side Rear Bracket	1
8	5127200F0	Driver Side Front Bracket	1
9	5127200B0	Driver Side Rear Bracket	1
10	S8T25	Aluminium Spoiler	1
11	Roller R01	1000mm	1
12	P9-C3 R3	M10 Nut	2
13	P9-C3 R2	Roller Plastic	2
14	Roller Yan Aparat	Right	1
15	Roller Yan Aparat	Left	1
16	M10x20 AKB Bolt	Stainles-Chrome	2
17	M8 Bolt's Cap	Black-Plastic	24
18	M8 Wide Washer	Stainless-Chrome	6
19	M8 Spring Washer	Stainless-Chrome	6
20	M8x25 AKB Bolt	Stainless-Chrome	6
21	M8x20 AKB Bolt	Stainless-Chrome	18
22	M8 Lock Nut	Stainless-Chrome	18
23	M8x25 Allen Bolt	Stainless-Chrome	12
24	M6 Spring Washer	Stainless-Chrome	4
25	M6x16 Allen Bolt	Stainless-Chrome	4
26	KC5128 Rubber	Rubber-Black	6
27	Sista Silicon	Silicon Package	1

INSTALLING BRACKETS TO THE ROOF RACK

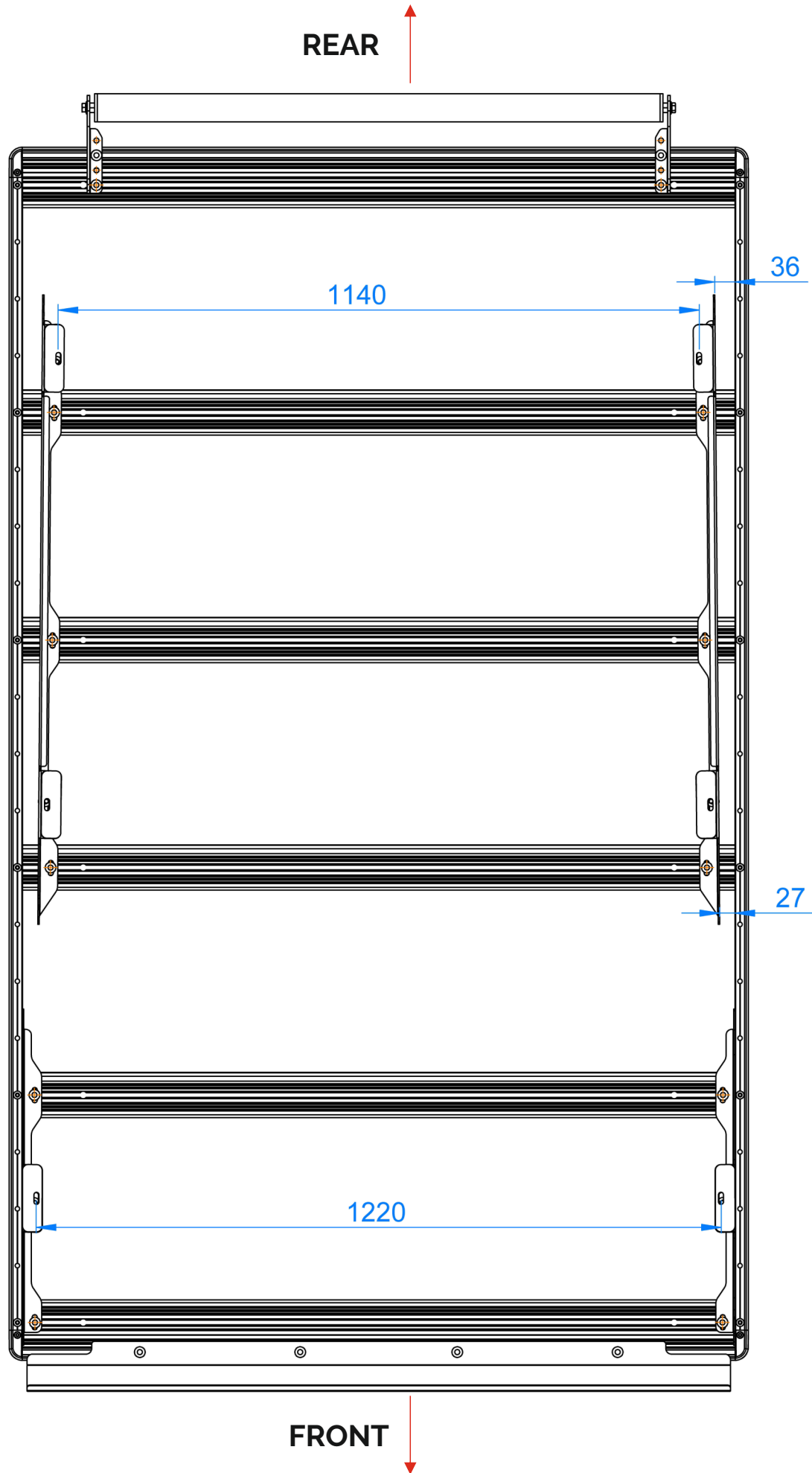

ASSEMBLY OF THE ROOF RACK ON THE VEHICLE

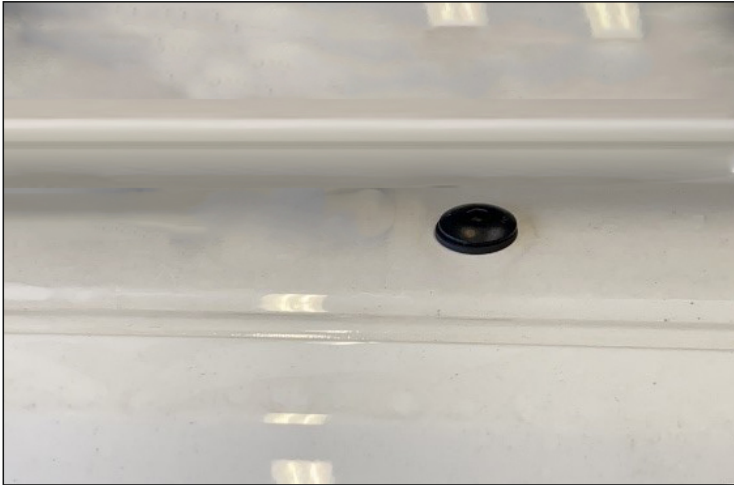

STEP-1 Remove factory rubber plugs as shown.

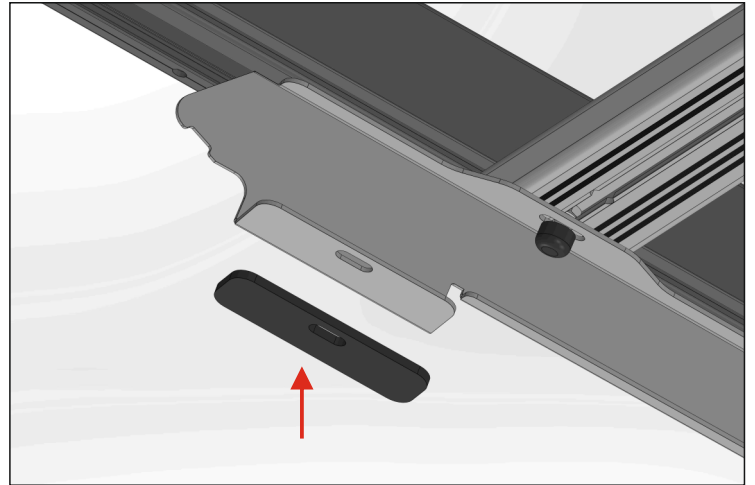

STEP-2 Put supplied rubber part in the bottom part of the bracket on the vehicle.

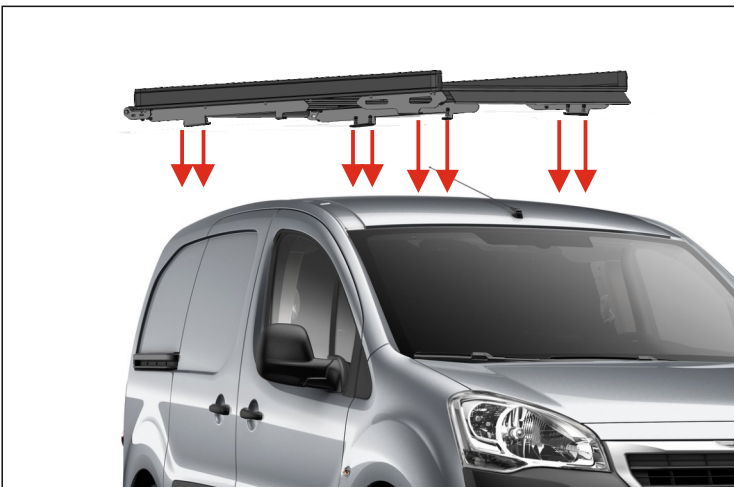

STEP-3 Match holes of the assembled roof rack to holes on the vehicle.

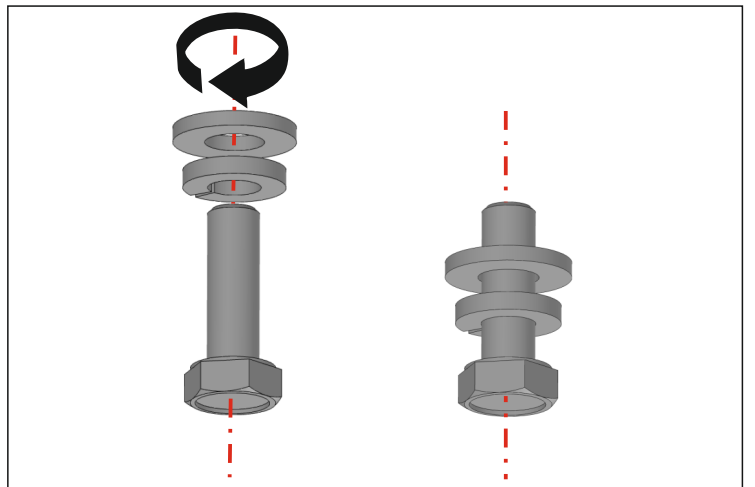

STEP-4 Attach spring washer first then flat washer to M8x25 hex bolts

STEP-5 Apply the silicon around the hole and pass to 6th step before it gets dry.

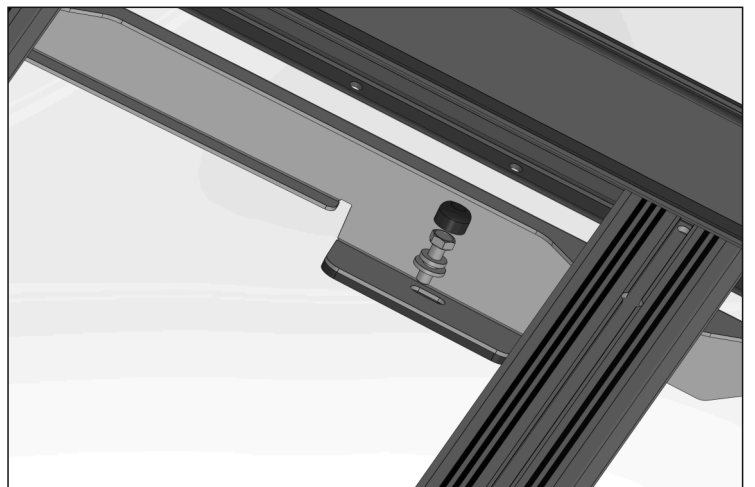

STEP-6 Fix the bracket with bolt to the holes on the vehicle. Repeat this process for all brackets.

CONTROL ALL INSTALLATION AND FINISH ASSEMBLY AFTER INSTALLING PLASTIC BOLT CAPS TO M8 HEX NUTS.

