

# BUSHRANGER

4x4 GEAR

5 YEAR  
WARRANTY



## NIGHT HAWK

SINGLE ROW LED LIGHT BAR

**VLI** VARIABLE LIGHT INTENSITY  
SERIES

# **BUSHRANGER**

**4x4 GEAR**

Congratulations on your purchase of the Bushranger® Night Hawk® Single Row Light Bar. To take full advantage of this product, please read this manual carefully before using. Retain this manual for future reference for installation and warranty.

# Specifications

## General Specifications

VOLTAGE RANGE	10-30VDC
LED TYPE	Genuine OSRAM LED's
COLOUR TEMPERATURE	5700K
CONTROL PLUG	4 pin custom (use with VLI Wiring System, sold separately)
COMPLIANCE	CE, UNECE R10, IP67 & IP69K, ROHS
COLOUR TEMPERATURE	5700K

## Individual Specifications

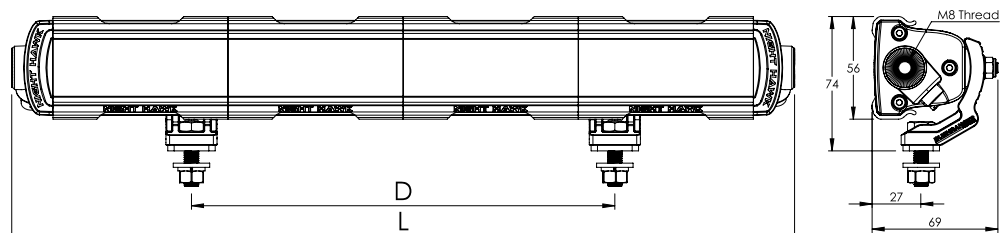

Part Number	Nominal Size	LED Quantity	Current Draw (@14.4V)	Power Draw	Effective Lumens	Power Plug	Qty of Covers Supplied	Qty of Mounting Feet Supplied	Overall Weight	Dimensions	
										Overall Length (L)	Mounting Hole Adjustment Range (D) *
NHT055VLI	5.5"	3	0.9A	13W	910	Deutsch DT	1 x Flood 1 x Diffused	1	0.50kg	141mm	-
NHT130VLI	13"	9	2.7A	39W	2750	Deutsch DT	3 x Spot 3 x Flood	2	1.10kg	333mm	Up to 258mm
NHT170VLI	17"	12	3.6A	52W	3670	Deutsch DT	4 x Spot 4 x Flood	2	1.35kg	429mm	Up to 354mm
NHT205VLI	20.5"	15	4.4A	63W	4590	Deutsch DT	5 x Spot 5 x Flood	2	1.60kg	525mm	Up to 450mm
NHT245VLI	24.5"	18	5.4A	78W	5510	Deutsch DT	6 x Spot 6 x Flood	2	1.85kg	621mm	Up to 546mm
NHT280VLI	28"	21	6.3A	90W	6420	Deutsch DT	7 x Spot 7 x Flood	2	2.10kg	717mm	Up to 642mm
NHT320VLI	32"	24	7.1A	102W	7340	Deutsch DT	8 x Spot 8 x Flood	2	2.35kg	813mm	Up to 738mm
NHT395VLI	39.5"	30	9.0A	129W	9180	Deutsch DT	10 x Spot 10 x Flood	3	3.00kg	1005mm	** Up to 930mm
NHT435VLI	43.5"	33	9.8A	141W	10100	Deutsch DTP	11 x Spot 11 x Flood	3	3.25kg	1101mm	** Up to 1026mm
NHT510VLI	51"	39	11.8A	170W	11940	Deutsch DTP	13 x Spot 13 x Flood	3	3.75kg	1292mm	** Up to 1218mm

\*When using mounting feet, all mounting feet supplied must be used, be fitted symmetrically about the centre of the light and positioned towards the ends of the light bar to reduce overhang.

\*\*Mounting hole adjustment range listed is the maximum distance that the two outer sliding feet can be adjusted apart. Where a third mounting foot is supplied, it should be mounted in the centre.

# Overview

Bushranger® Night Hawk Single Row LED Light Bars have been developed from the ground up by our team of engineers to offer a compact and low-profile design which takes performance, looks and usability to a whole new level.

The clean, modern aesthetic incorporates quality materials and construction and provides a unique and versatile mounting system that makes installation a breeze. The Advanced Temperature Control System takes advantage of the quality aircraft grade aluminium heatsink to run the LED's at their maximum potential by monitoring and adjusting the output according to the environment.

These lights are so bright, we've also incorporated a brightness control function which allows complete control of the light intensity in adverse conditions, where too much light can be detrimental to clear vision. The brightness is controlled by our pioneering, relay-free VLI series wiring system, which is the first of its kind, and leads the way with simpler wiring, easier installation, more user control and greater reliability over traditional systems.

For 5.5" lights, each is supplied with two protective covers, a Flood Beam and a Diffused Beam, which allow quick and easy customisation of the beam pattern to suit any requirement. Clip on the Diffused protective cover to experience a dedicated work light beam pattern, which provides a smooth, indirect wall of light over the immediate work area for excellent, short distance illumination. Change over to the flood protective cover to achieve a wide, flood beam pattern which lights up all the surroundings for excellent medium distance vision. Remove the covers completely to achieve a clean, focused Spot Beam pattern which reaches incredible distance for a small, compact light.

For lights 13" and above, each is supplied with a full set of protective spot beam covers plus a full set of protective flood beam covers, which allow quick and easy customisation of the beam pattern to suit any requirement. With the spot protective covers fitted, the light projects a clean, focused spot beam pattern which reaches extreme distance; great for highway driving. Clip on the flood protective covers and the light changes significantly to a wide, flood beam pattern which illuminates all the surroundings for excellent short to medium distance vision. Run any combination of each cover to tailor the perfect combo beam pattern for the environment.

Bushranger® Night Hawk lights are engineered tough to withstand the rugged outdoor terrain and harsh climate experienced down under. They are backed by a 5 year warranty and our 40+ year history of supplying quality engineered 4x4 products to the Australian market.

## Key Features

### High Output OSRAM LED's

- Genuine, high output OSRAM LED's produce huge effective lumens outputs for each size in the range.
- Unrivaled 1lux distance and width performance for slimline single row light bars
- Tested by an Australian NATA accredited photometry lab to produce real light performance data.

### Active Temperature Control System

- Intelligent onboard monitoring of the LED temperatures, combined with a quality heatsink design, allows for maximum output in all conditions.

### Modern Electronics Design

- Built in Transistor switching simplifies wiring installation by removing the need for traditional 12V relays.
- PWM dimming capability for brightness control at the turn of a dial
- Over voltage and Reverse Polarity Protection.

### Changeable Beam Pattern

- Full set of clip on/clip off spot beam and flood beam protective covers for 13" and up lights allows for complete customization of beam pattern
- 5.5" light supplied with Diffused and Flood covers for more versatile work light options, or remove cover completely for a dedicated Spot beam pattern.

### Built Tough

- Extruded, 6061 aircraft grade aluminium housing and cast alloy mounting feet offers long term strength and durability.

### Durable Exterior

- UV stable polyester powder coat, polycarbonate lens and covers ensure long term durability to handle even the toughest Australian conditions.

### Sealed Tight

- Waterproof and submersible, IP67 & IP69K rated with Genuine GORE breather, to manage the internal air pressure of the light.

### Versatile Installation

- Lightweight and low-profile design with highly adjustable sliding mounting feet allows for diverse fitment.

## Light Performance

Part Number	SIZE	Full set of Spot Covers		Full set of Flood Covers	
		Max Distance @ 1lux	Max Primary Beam Width @ 1lux	Max Distance @ 1lux	Max Primary Beam Width @ 1lux
NHT055VLI	5.5"	267m	15m	126m (with Flood Cover) 43m (with Diffused Cover)	39m (with Flood Cover) 20m (with Diffused Cover)
NHT130VLI	13"	462m	26m	218m	69m
NHT170VLI	17"	534m	30m	252m	79m
NHT205VLI	20.5"	597m	34m	282m	89m
NHT245VLI	24.5"	654m	38m	309m	96m
NHT280VLI	28"	706m	40m	334m	105m
NHT320VLI	32"	755m	43m	357m	112m
NHT395VLI	39.5"	844m	48m	399m	125m
NHT435VLI	43.5"	886m	51m	418m	132m
NHT510VLI	51"	963m	55m	454m	143m

# Isolux Data

All results shown below are obtained from real scientific testing carried out by a NATA Accredited Photometric Laboratory in Australia.

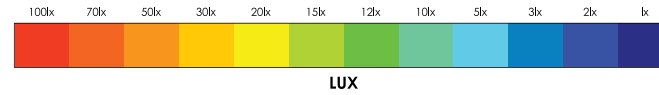

## NHT055VLI (5.5") – SPOT BEAM (NO COVER FITTED)

Max distance @ 1lux = 267m | Max Primary Beam Width @ 1lux = 15m

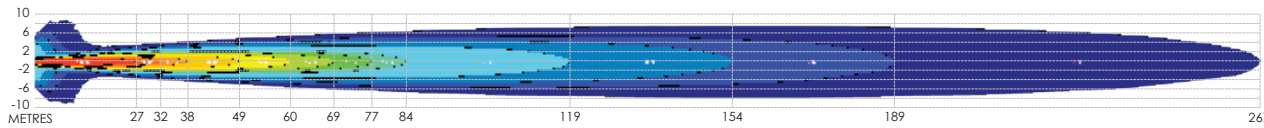

## NHT055VLI (5.5") – 1 x DIFFUSED COVER

Max distance @ 1lux = 43m | Max Primary Beam Width @ 1lux = 20m

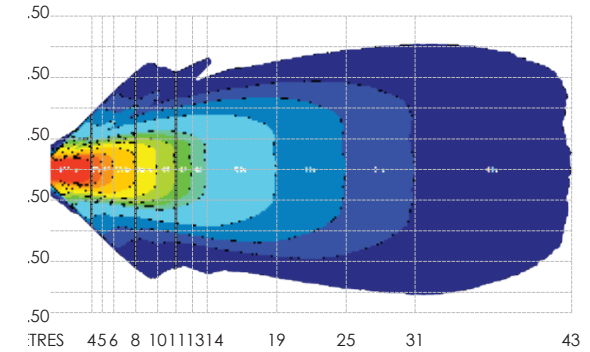

## NHT055VLI (5.5") – 1 x FLOOD COVER

Max distance @ 1lux = 126m | Max Primary Beam Width @ 1lux = 39m

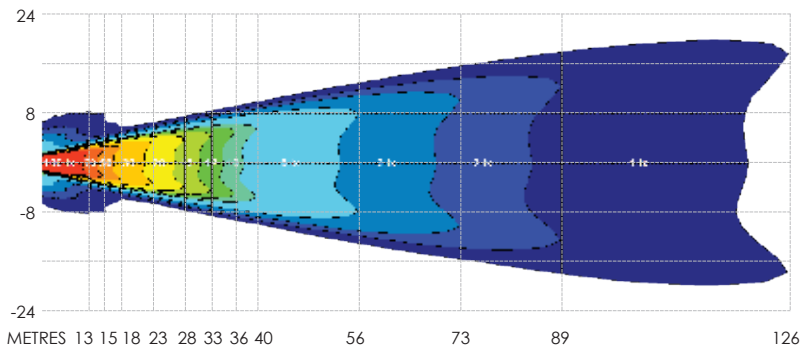

## NHT130VLI (13") – 3 x FLOOD BEAM COVERS

Max distance @ 1lux = 218m | Max Primary Beam Width @ 1lux = 69m

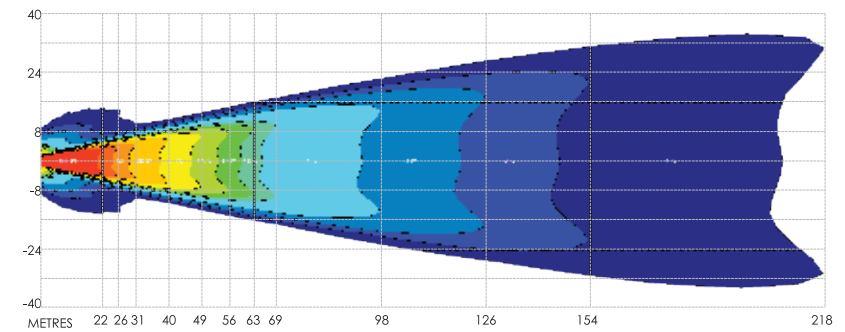

## NHT130VLI (13") – 3 x SPOT BEAM COVERS

Max distance @ 1lux = 462m | Max Primary Beam Width @ 1lux = 26m

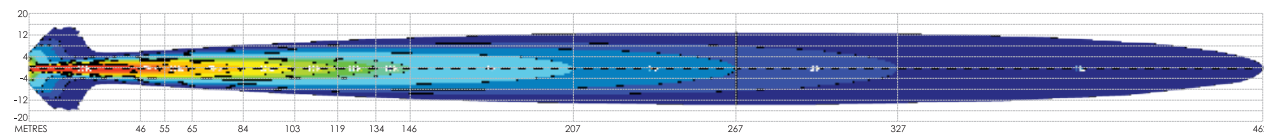

# Isolux Data

All results shown below are obtained from real scientific testing carried out by a NATA Accredited Photometric Laboratory in Australia.

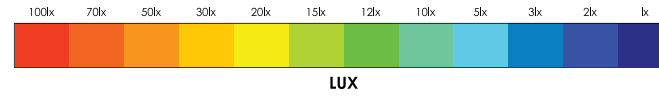

## NHT170VLI (17") – 4 x SPOT BEAM COVERS

Max distance @ 1lux = 534m | Max Primary Beam Width @ 1lux = 30m

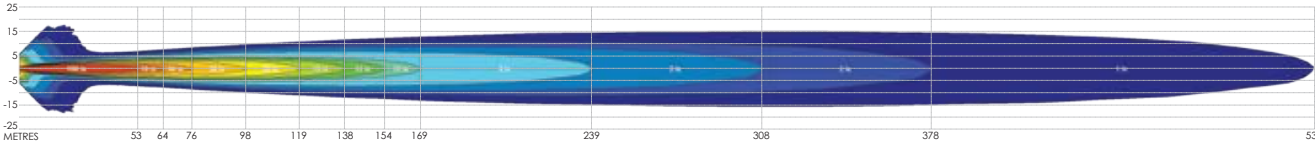

## NHT170VLI (17") – 4 x FLOOD BEAM COVERS

Max distance @ 1lux = 252m | Max Primary Beam Width @ 1lux = 79m

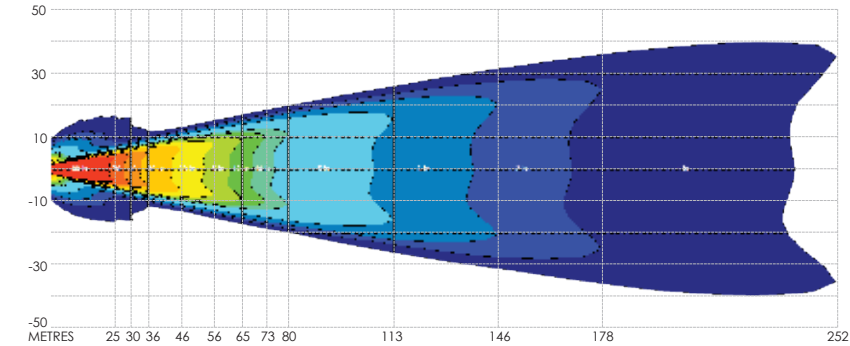

## NHT205VLI (20.5") – 5 x SPOT BEAM COVERS

Max distance @ 1lux = 597m | Max Primary Beam Width @ 1lux = 34m

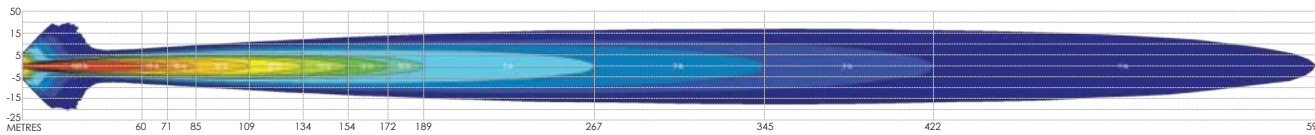

## NHT205VLI (20.5") – 5 x FLOOD BEAM COVERS

Max distance @ 1lux = 282m | Max Primary Beam Width @ 1lux = 89m

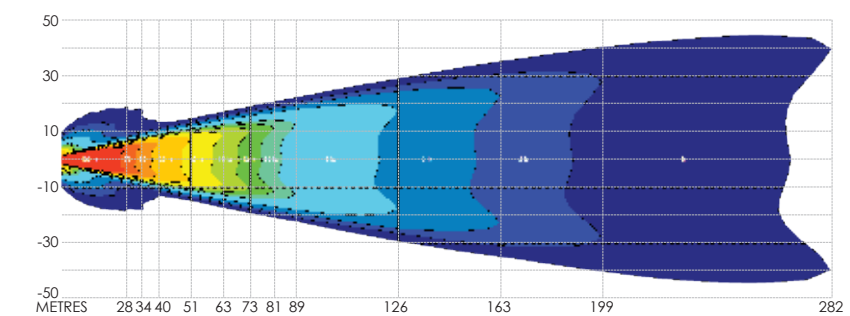

## NHT245VLI (24.5") – 6 x SPOT BEAM COVERS

Max distance @ 1lux = 654m | Max Primary Beam Width @ 1lux = 38m

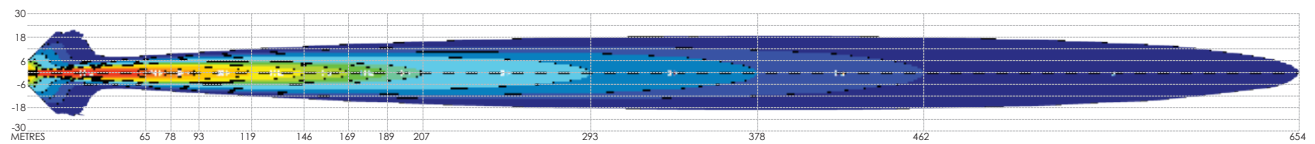

## NHT245VLI (24.5") – 6 x FLOOD BEAM COVERS

Max distance @ 1lux = 309m | Max Primary Beam Width @ 1lux = 96m

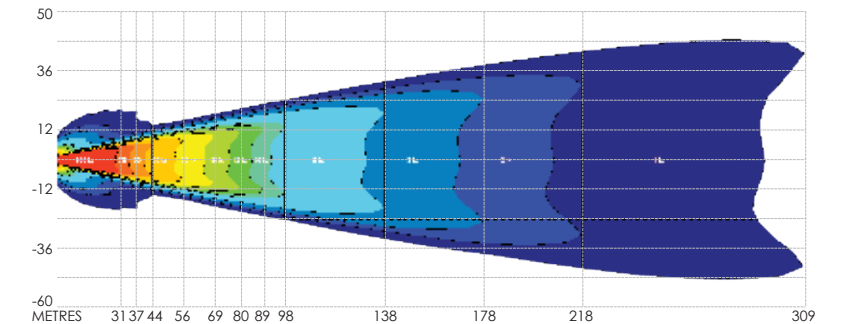



# Isolux Data

All results shown below are obtained from real scientific testing carried out by a NATA Accredited Photometric Laboratory in Australia.

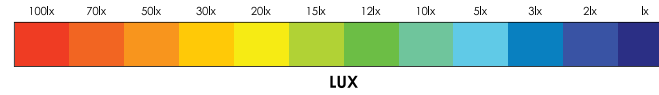

## NHT280VLI (28") – 7 x SPOT BEAM COVERS

Max distance @ 1lux = 706m | Max Primary Beam Width @ 1lux = 40m

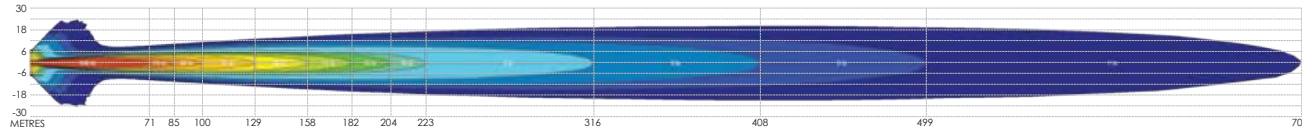

## NHT280VLI (28") – 7 x FLOOD BEAM COVERS

Max distance @ 1lux = 334m | Max Primary Beam Width @ 1lux = 105m

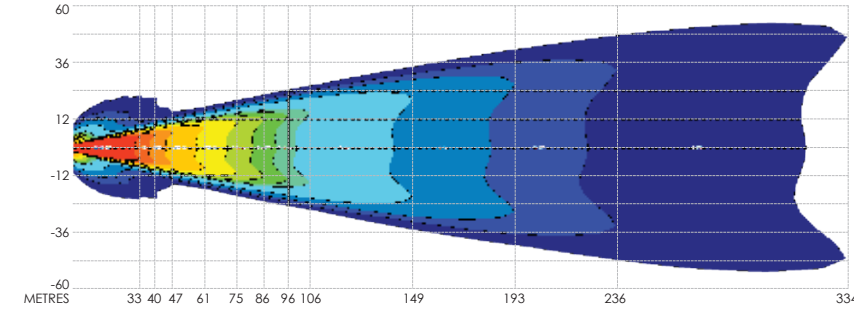

## NHT320VLI (32") – 8 x SPOT BEAM COVERS

Max distance @ 1lux = 755m | Max Primary Beam Width @ 1lux = 43m

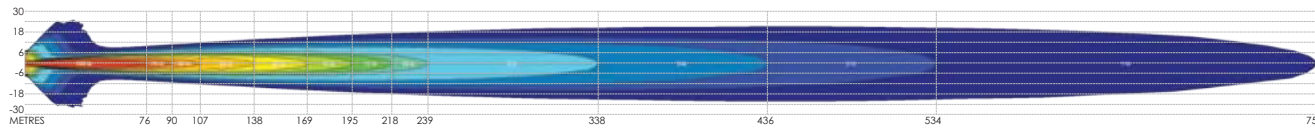

## NHT320VLI (32") – 8 x FLOOD BEAM COVERS

Max distance @ 1lux = 357m | Max Primary Beam Width @ 1lux = 112m

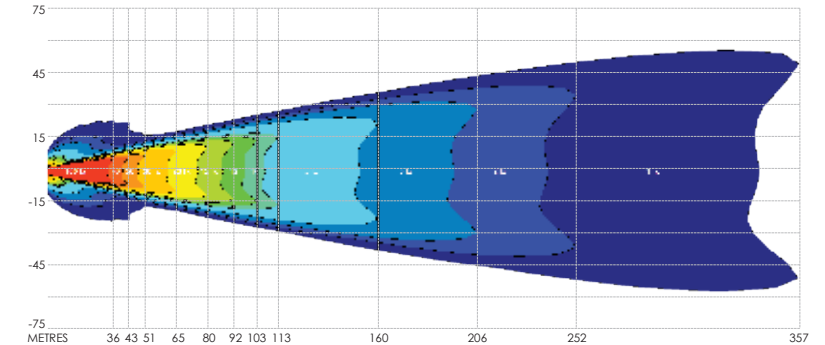

## NHT395VLI (39.5") – 10 x SPOT BEAM COVERS

Max distance @ 1lux = 844m | Max Primary Beam Width @ 1lux = 48m

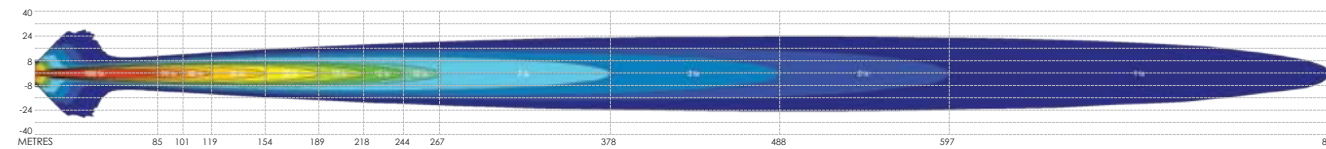

## NHT395VLI (39.5") – 10 x FLOOD BEAM COVERS

Max distance @ 1lux = 399m | Max Primary Beam Width @ 1lux = 125m

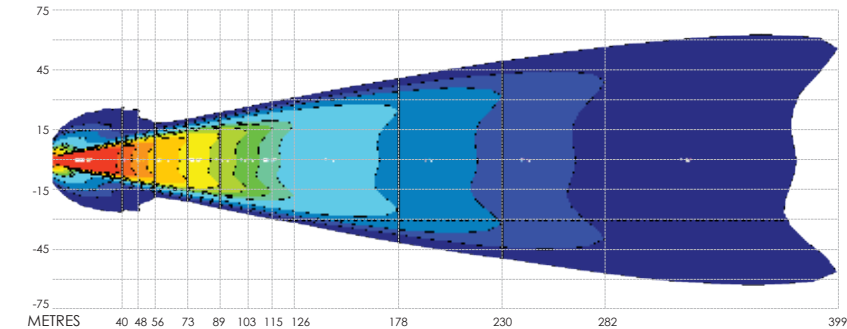

# Isolux Data

All results shown below are obtained from real scientific testing carried out by a NATA Accredited Photometric Laboratory in Australia.

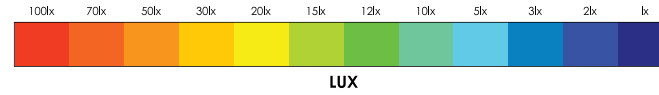

**NATA** ACTUAL PHOTOMETRIC TEST DATA  
PERFORMED BY NATA  
ACCREDITED LABORATORY  
IN AUSTRALIA

## NHT435VLI (43.5") – 11 x SPOT BEAM COVERS

Max distance @ 1lux = 886m | Max Primary Beam Width @ 1lux = 51m

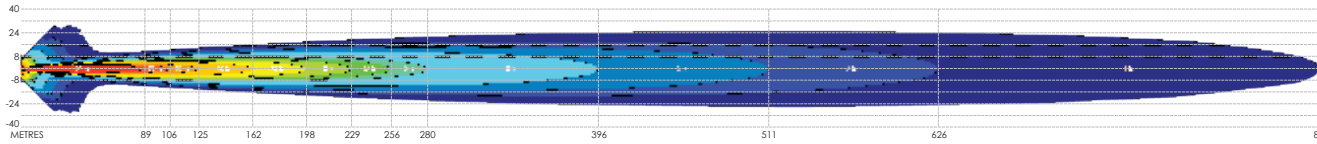

## NHT435VLI (43.5") – 11 x FLOOD BEAM COVERS

Max distance @ 1lux = 418m | Max Primary Beam Width @ 1lux = 132m

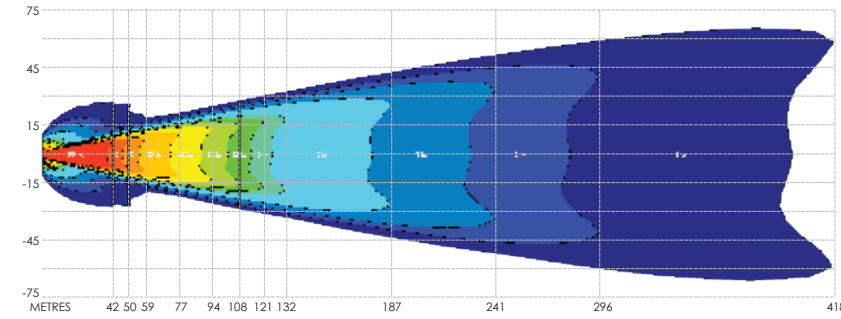

## NHT510VLI (51") – 13 x SPOT BEAM COVERS

Max distance @ 1lux = 963m | Max Primary Beam Width @ 1lux = 55m

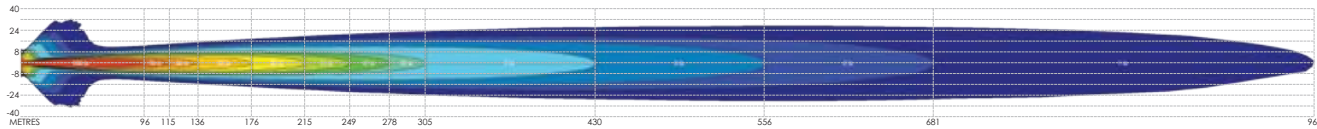

## NHT510VLI (51") – 13 x FLOOD BEAM COVERS

Max distance @ 1lux = 454m | Max Primary Beam Width @ 1lux = 143m

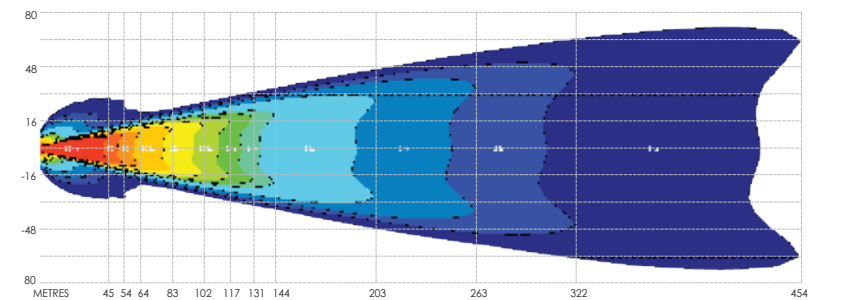



## Components Supplied

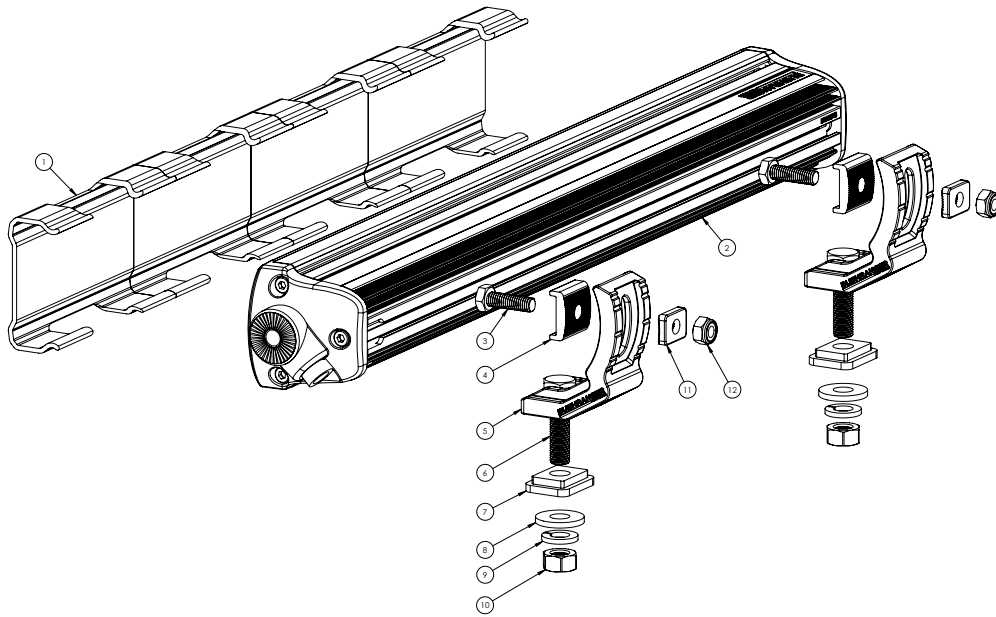

Item#	Component Name
1	Protective Covers
2	NHT Light Bar
3	M6x20mm Hex Bolt
4	Mount Adaptor
5	Mounting Foot
6	M8x30mm Hex Bolt
7	Rubber Isolator
8	M8 Flat Washer
9	M8 Spring Washer
10	M8 Hex Nut
11	Radius Washer
12	M6 Nyloc Nut
13	Power Lead 2.5m with fuse (Not Shown)
14	Anti-Seize Lubricant Sachet (not shown)

## Installation Instructions

### Important Notes

- We recommend the lights / wiring to be fitted by a qualified automotive electrician.
- A forward facing light system may be used only as an auxiliary to high beam. Check compliance and regulations with local authorities.
- Vehicle accessories mounted on the outside of the vehicle may need to comply with regulations governed by your local state authority. Please check before installation.
- When mounting lights, position them appropriately so they do not obstruct existing automotive function. If fitting to front of vehicle, check for Bonnet clearances.
- Consideration should be given for airflow requirements of the vehicle and its mechanical components when mounting lights.
- All stainless steel hardware must have anti-seize applied to the threads before tightening to avoid binding or galling of components.
- Ensure all recyclable Parts/Packaging are discarded in accordance to local regulations.

### Light Mounting Feet

The NHT Light Bar series have been designed to offer a highly adaptable mounting arrangement. The light mounting feet can be slid along the body of the light bar and rotated a full 200° around to suit the majority of mounting applications.

The mounting feet supplied with each light bar can be fitted to the rear or underside sliding channels incorporated into the light bar body. Slide the head of the M6x20mm Hex Bolt (Item 3) into the selected channel by inserting it through the opening at one end of the body (marked with red arrows below). The remaining components can then be assembled onto the bolt to secure the mounting foot to the light bar.

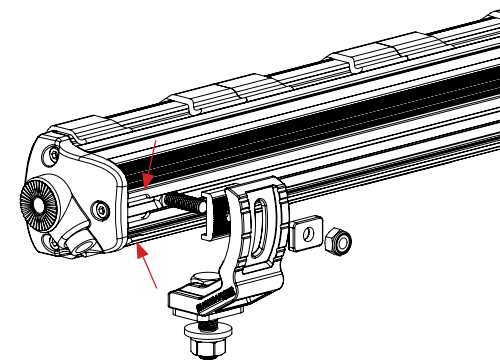

## Angle Adjustment

The mounting feet can be moved through 200° rotation by utilising the two individual channels in the body of the light bar and the two hole positions in the mounting feet. All configurations shown below:

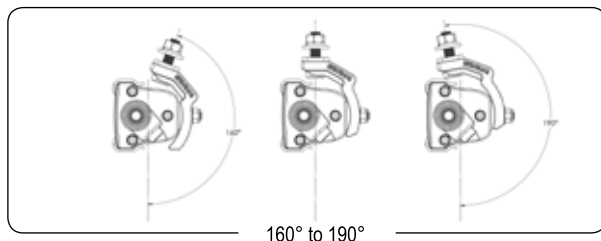
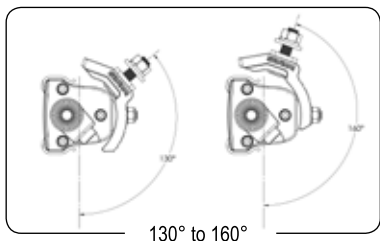
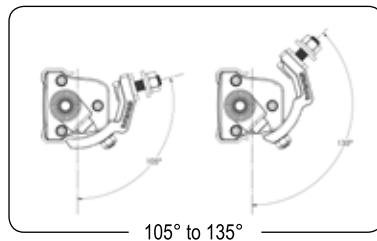
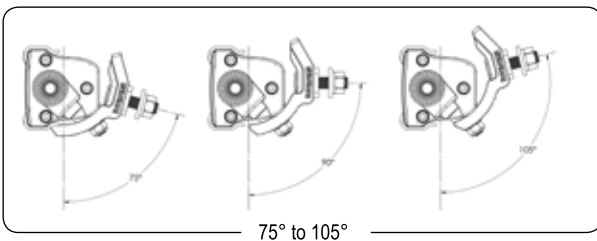
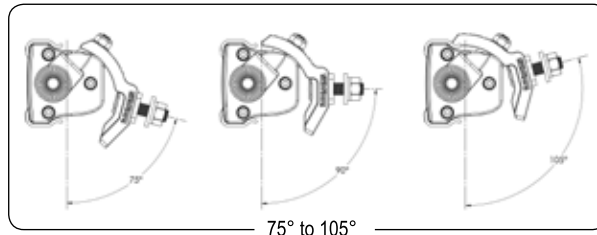
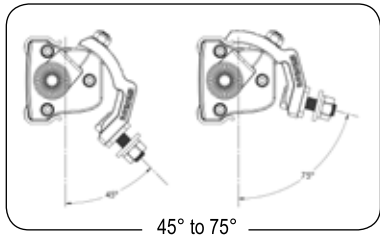
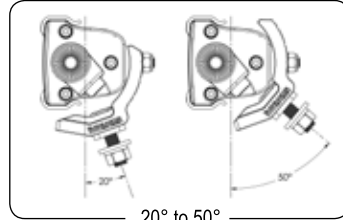
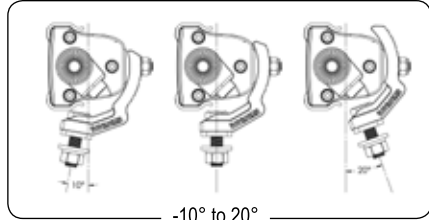

## Vehicle Mounting & Adjustment

Light bars can be mounted using the supplied mounting feet or tube clamps are available (sold separately) for bar mounting applications. When using mounting feet, all mounting feet supplied must be used, be fitted symmetrically about the centre of the light and positioned towards the ends of the light bar to reduce overhang.

Ensure the mounting location for fitment of the light/s to the vehicle is flat, stable, sufficiently strong and has enough clearance around the light to avoid damage to the vehicle from any movement during installation and use. If drilling is required for mounting, ensure raw edges are coated with corrosion resistant paint or inhibitor.

**Apply anti-seize lubricant to the threads before final installation.** The use of anti-seize greatly reduces the risk of thread galling or binding commonly seen between stainless steel nuts and bolts during tightening. Tighten fasteners to the following torque specifications:

### RECOMMENDED TORQUE SETTINGS

M6 Fasteners	8Nm
M8 Fasteners	22Nm

### Wiring Options

The light bars can be wired into the vehicle using 2 methods:

#### 1. VLI Wiring System (P/N: NHW20VLI, available separately)

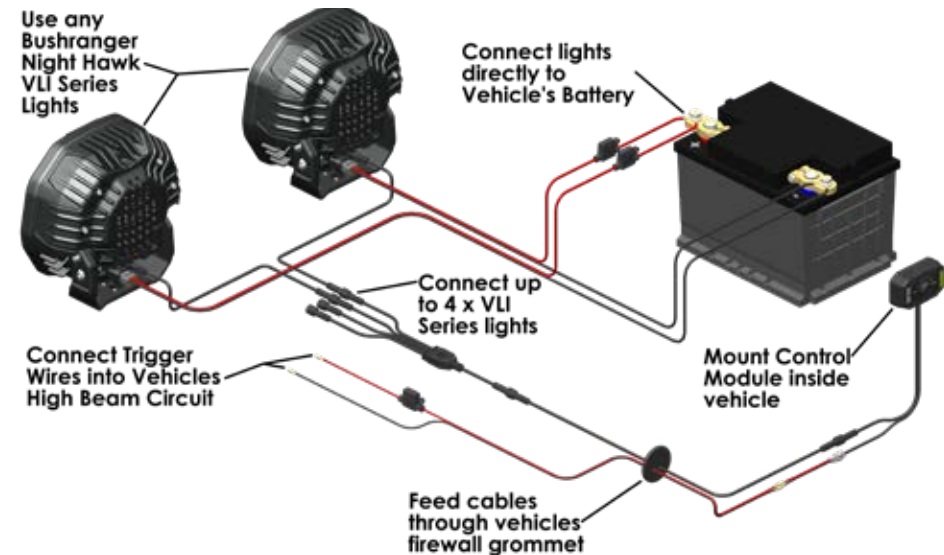

Our unique, relay free Variable Light Intensity Series wiring system greatly simplifies the installation of these light bars into modern vehicles and allows the full functionality of the VLI Series lights to be achieved. Not only is this system easier to install and more reliable than traditional relay-based wiring looms, but it also allows the brightness of all lights connected to be varied, which gives the driver full control of light intensity at the turn of a dial. Up to 4 x VLI Series Lights can be controlled by the one system with no limitations on the power draw of each light.

The VLI Wiring System utilises the 4 pin control plug that comes from the side of the light bars to provide the control signals. The basic principles of operation are: When the control plug is connected to the wiring system, and the power plug is connected directly to the vehicles battery using the supplied power lead, the light will only turn on/off & vary in brightness when signals are received from the in-cabin control module. The in-cabin control module is connected through the vehicles high beam circuit so that the lights can only be operated when the high beam is activated.

**NOTE:** After installation of the wiring system, the light may briefly flash when first connected to the power source. This is normal operation and not a malfunction.

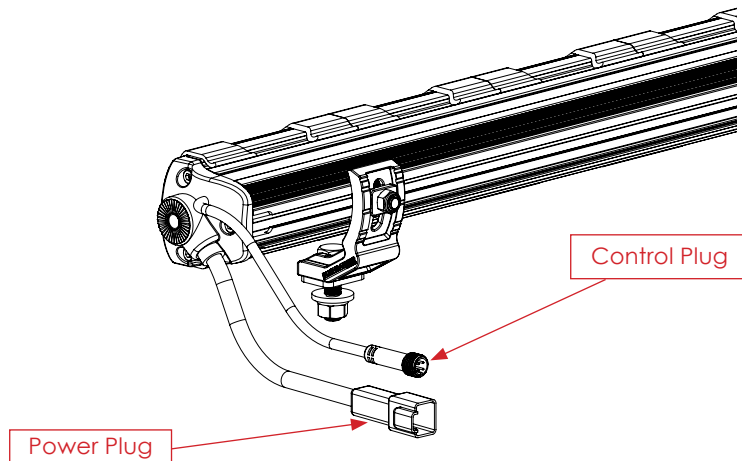

## 2. Traditional Wiring Looms

All VLI Series lights can also be used in a more traditional, 12V relay-based wiring loom / harness setup. Care needs to be taken to ensure that the wiring harness is rated for the high-power requirements of the VLI Series lights.

The basic principles of operation are:

When the control plug is not used and power is supplied to the power plug, the light will turn on and operate at maximum output. Ensure that the attached sealing cap is fitted to the control plug when not in use.

## Care and Maintenance

- The light is not serviceable – DO NOT disassemble.
- Clean lights using pH neutral soapy water and a soft nonabrasive brush or sponge. Rinse thoroughly after cleaning.
- DO NOT use solvents, Alkaline based cleaners or abrasive materials to clean the light.
- If lights are exposed to a high salt environment or any other corrosive substance, remove the light and mounting bracket from the vehicle and thoroughly clean and rinse the components as outlined above.
- Remove the clear covers periodically to clean any dirt and grime build up.
- Regularly check all fasteners to ensure they are secured and properly torqued.

## KINGSLEY PRODUCTS - WARRANTY POLICY

### 1. Our Warranty

We warrant to you that the Kingsley product is free from defects in workmanship and materials for the warranty period.

### 2. Fitting and use

Please ensure you:

- a. fit the Kingsley product in accordance with the product information and all relevant vehicle safety and compliance laws
- b. use the Kingsley product for the purpose for which it was originally designed and in accordance with the product information and all relevant vehicle safety and compliance laws

### 3. Exclusions

Our warranty doesn't cover:

- a. normal wear and tear
- b. fitting the Kingsley product other than in accordance with the product information and any relevant vehicle safety and compliance laws, including incorrect fitting
- c. using the Kingsley product other than for the purpose for which it was originally designed or other than in accordance with the product information and any relevant vehicle safety and compliance laws, including unusual, improper or negligent use or misuse or overloading
- d. misuse or neglect of the Kingsley product, including improper repair or maintenance or failing to repair or maintain
- e. alteration, abuse, acts of nature, terrorism, vandalism, collision, road hazards or adverse conditions

### 4. Making a claim

Please immediately contact us as soon as you become aware of a possible defect in the Kingsley product. We'll arrange for you to either attend a Kingsley outlet (at your cost) for a Kingsley representative to inspect the Kingsley product (as fitted to your vehicle) or for you to return the Kingsley product to us. We'll also request you to provide the purchase receipt and complete a warranty claim form. In order to ensure our warranty is not voided, please keep the purchase receipt as proof of purchase and don't remove the fitted Kingsley product from your vehicle before contacting us. Note: Non-transferable warranty. The original purchaser can only claim warranty. If your claim's in order, we'll notify you and (at our sole discretion) either repair or replace the defective workmanship or materials (at our cost) or refund to you the purchase price you paid for the defective Kingsley product. If further information or investigation is required or if the claim does not meet the requirements under our warranty, we'll let you know.

### 5. Australian Consumer Law

The Kingsley product comes with guarantees that can't be excluded under the Australian Customer Law. You're entitled to a replacement or refund if there's

a major failure and compensation for any other reasonably foreseeable loss or damage. You're also entitled to have the Kingsley product repaired or replaced if it fails to be of acceptable quality and the failure doesn't amount to a major failure.

### 6. Other consumer rights

The benefits to you under our warranty are in addition to any other rights and remedies you are entitled to under relevant consumer laws. Our warranty replaces any other warranty given by Kingsley or it's supplier in respect of the Kingsley product.

### 7. Terms

The following terms have the following meanings:

Term	Meaning
Product information	information about the Kingsley product which may be contained in any of the documentation provided with the Kingsley product, including safety instructions, installation instructions, operating instructions, owner's manual, service manual, labels and packaging
Purchase date	the date you purchased the Kingsley product from a Kingsley outlet, as specified in the purchase receipt
Kingsley outlet	an outlet authorised by Kingsley to sell Kingsley products
Kingsley products	products or components which Kingsley manufacturers or sells through Kingsley outlets
Warranty period	commences on and from the purchase date and ends as follows: <b>Night Hawk Single Row LED Light Bar - 5 year warranty</b>
We/Us	Kingsley Enterprises Pty Ltd (ABN 23 001 592 749) E: sales@kingsleyenterprises.com.au A: 6A Brooks Road, Ingleburn NSW 2565 P: 1800 654 767 W: www.kingsleyenterprises.com.au
You	the purchaser of the Kingsley product from a Kingsley outlet

# **BUSHRANGER**

---

**4x4 GEAR**

[bushranger.com.au](http://bushranger.com.au)



Free Call | 1800 654 767 (Australia only)

International | +61 2 8700 0400

Fax | +61 2 8700 0499

Email | [sales@kingsleyenterprises.com.au](mailto:sales@kingsleyenterprises.com.au)

Address | 6A Brooks Road, Ingleburn NSW 2565