

Mounting instructions

Side steps series: AT - ATZ

Ford Transit Custom 2012+



50 Min.

Version: January 2018



M6 = 10 Nm
 M8 = 25 Nm
 M10 = 50 Nm

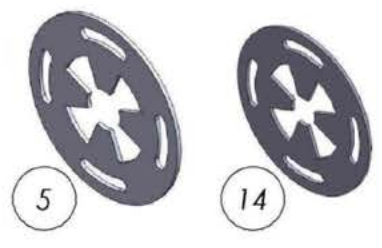
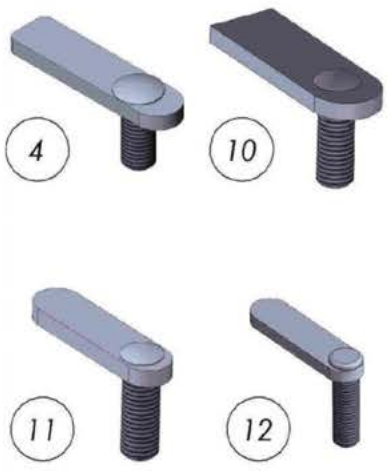
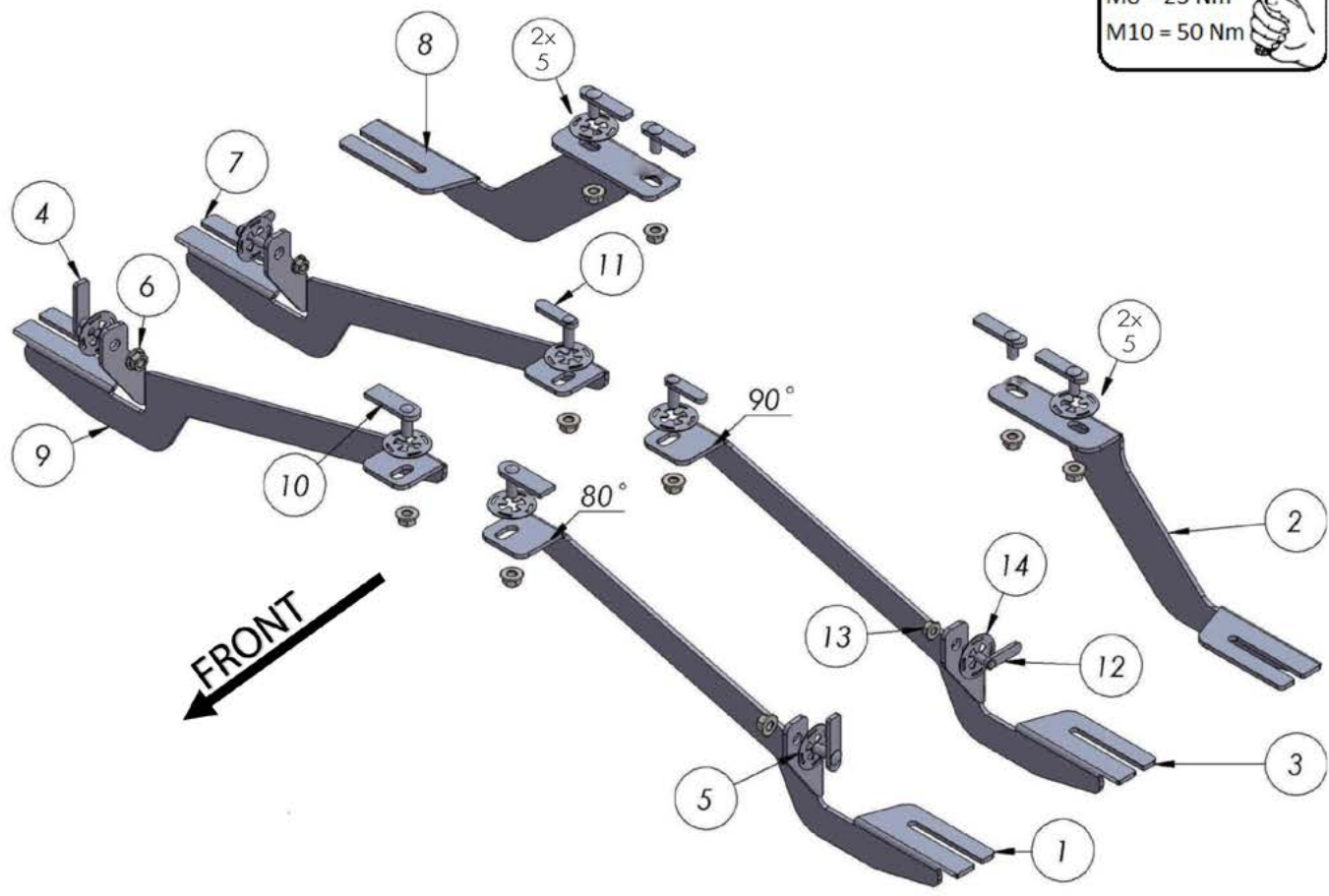

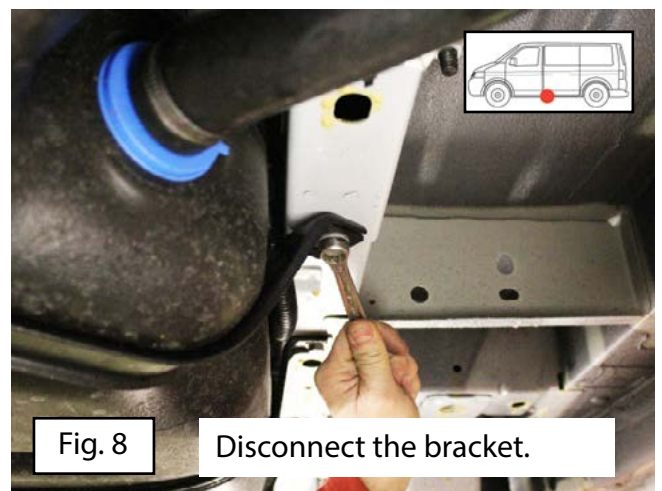
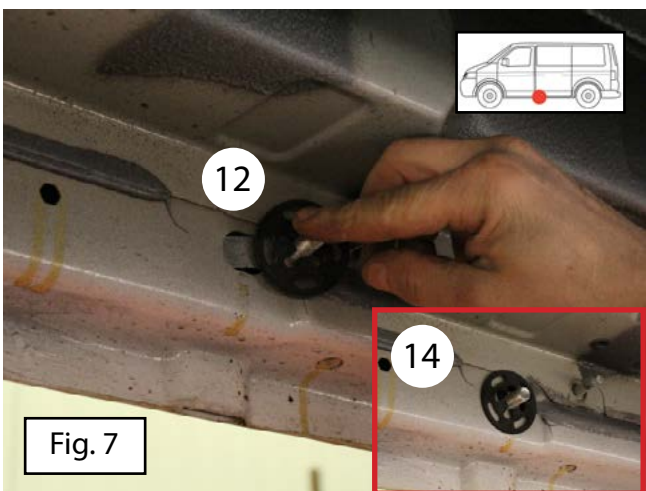
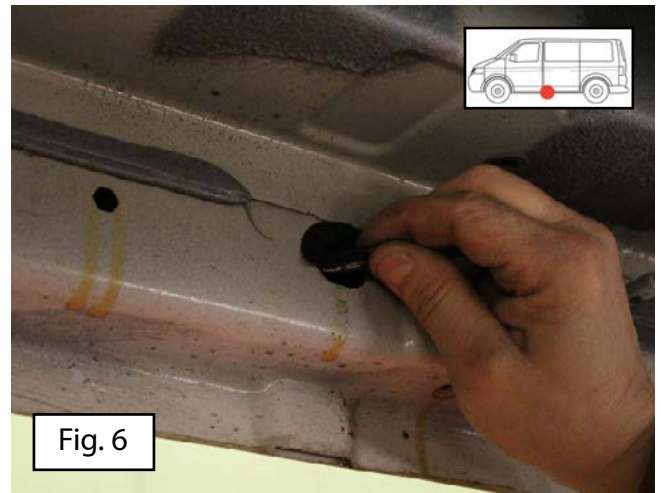
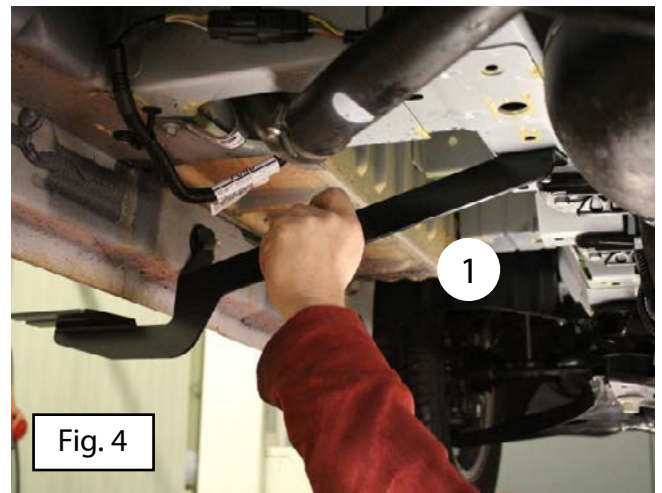
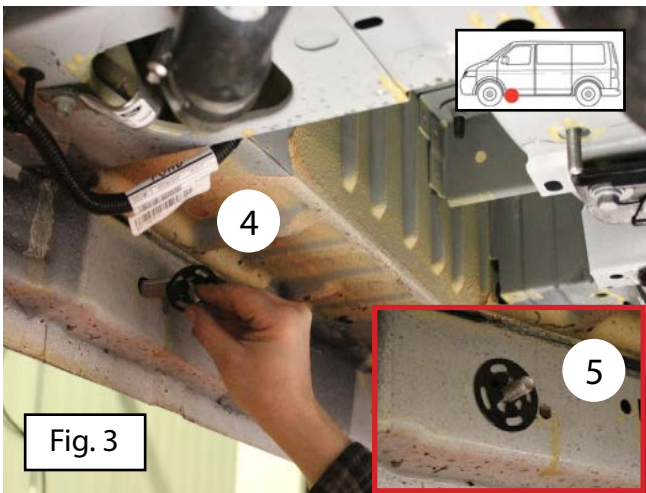
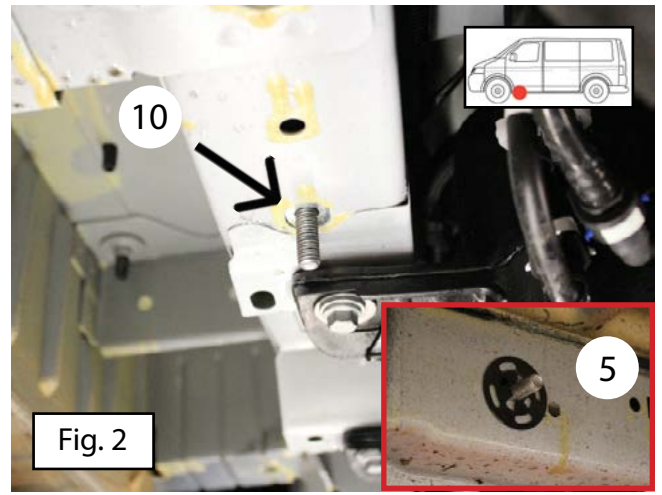
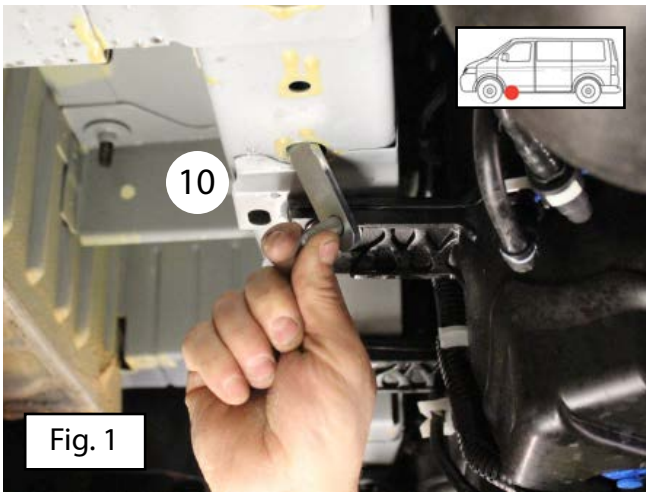

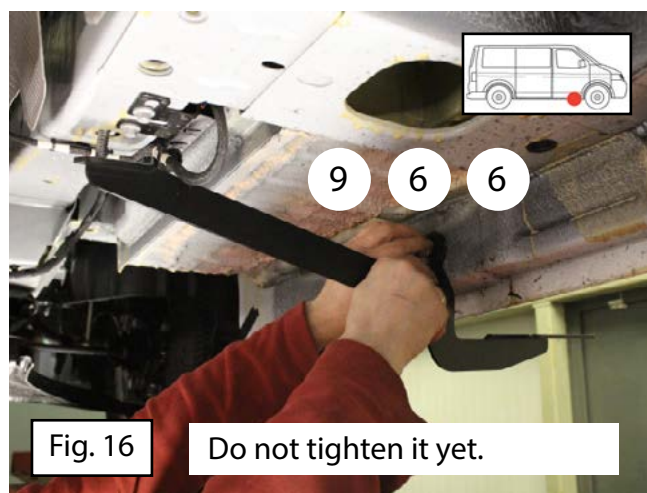
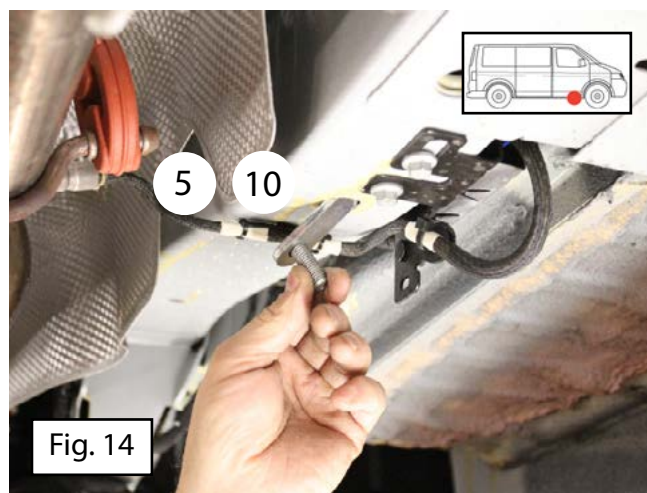
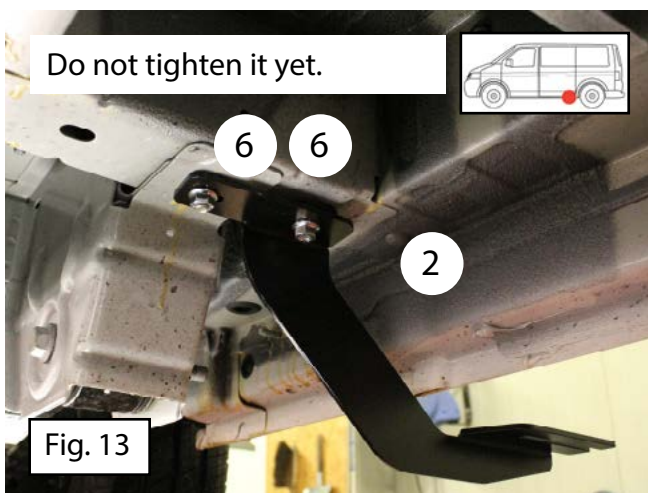
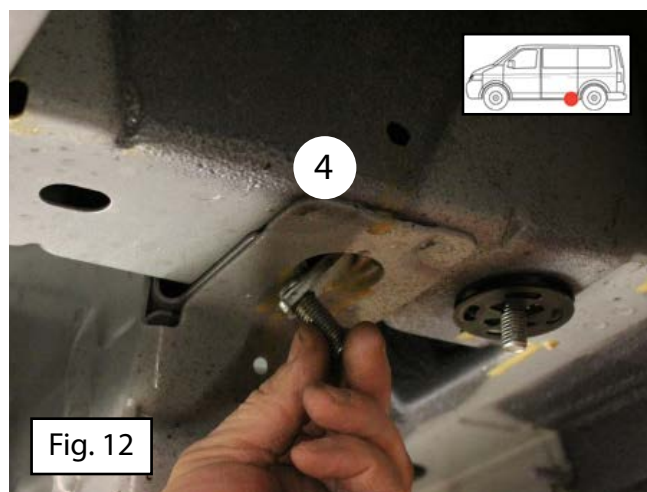
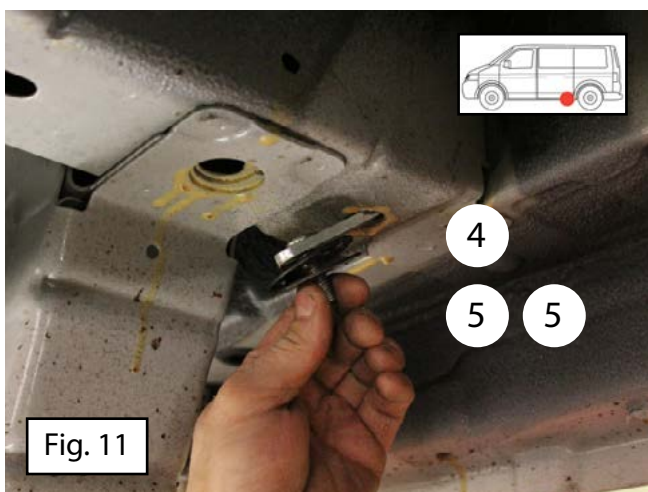
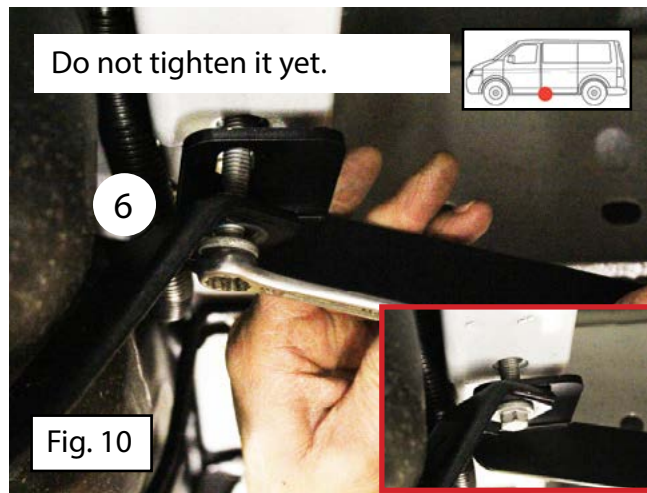
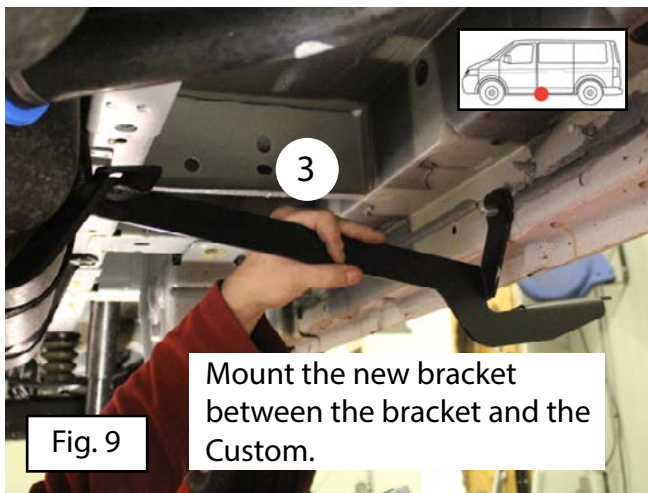
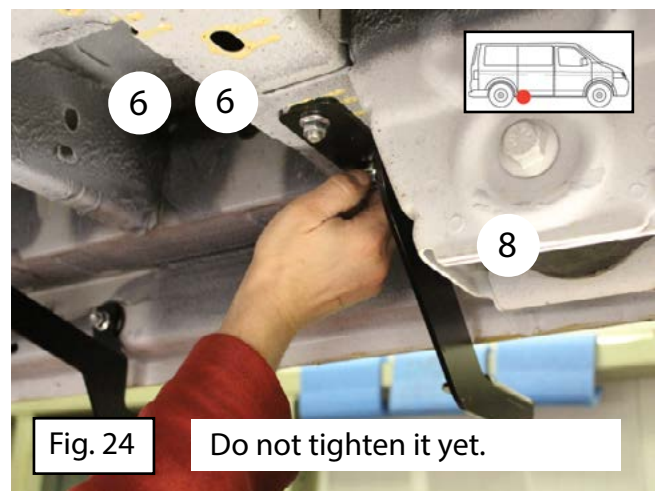
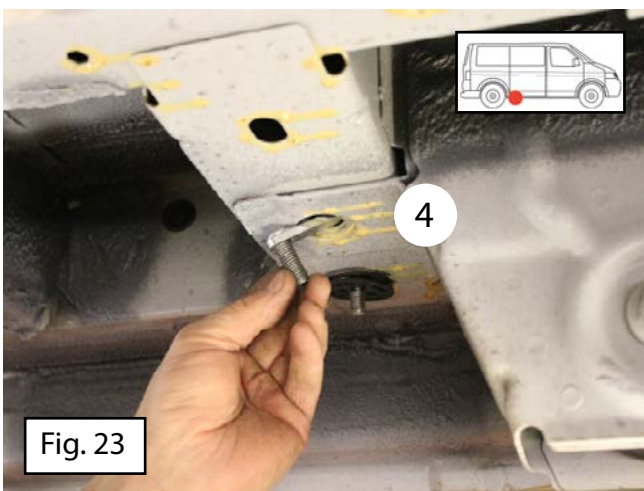
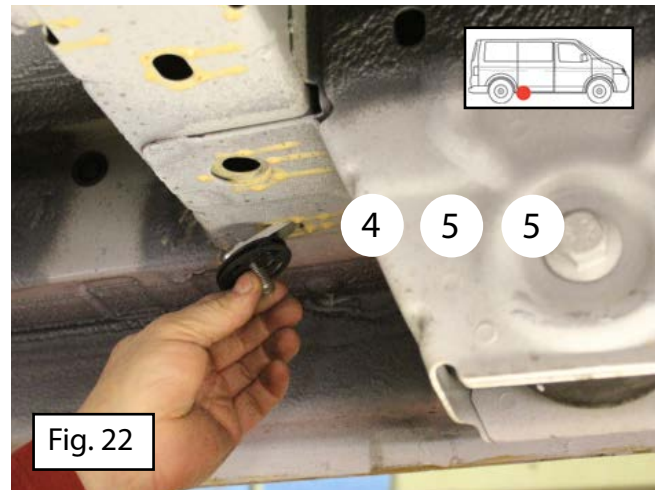
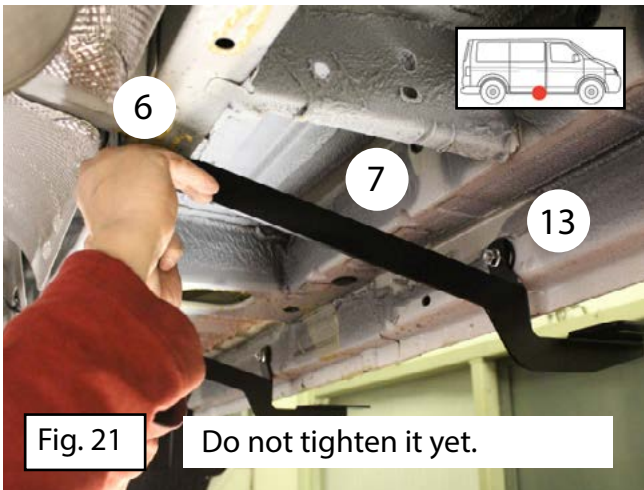
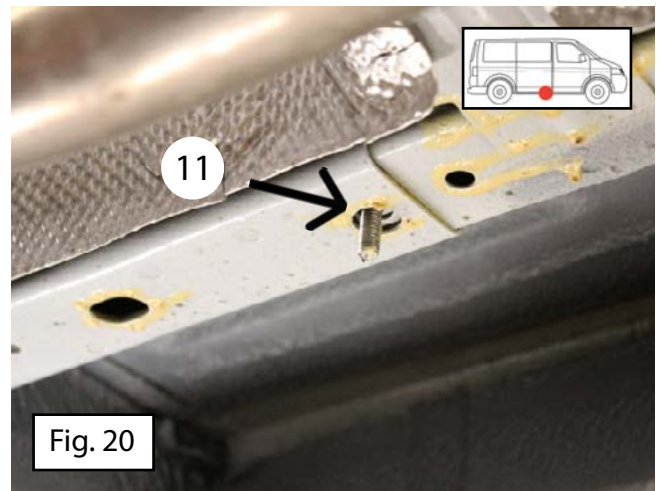
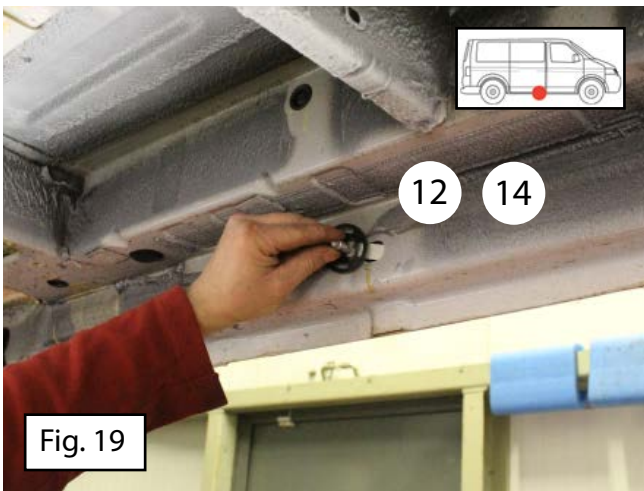



Fig. 25

Make sure that the screws at the bottom of the Side step are loose.



Fig. 26

Slide the Side step on the brackets.

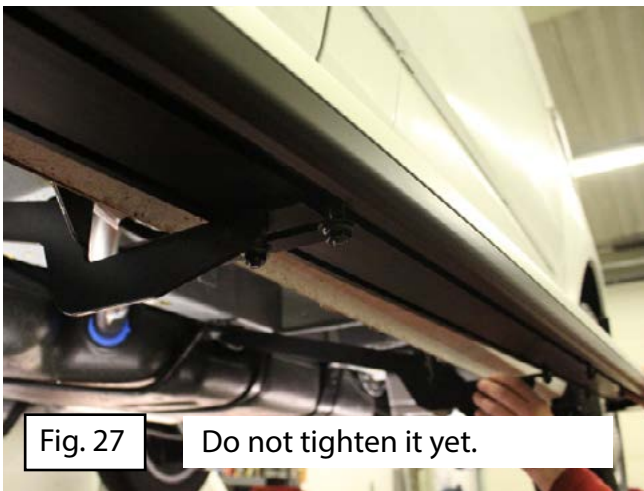

Fig. 27

Do not tighten it yet.

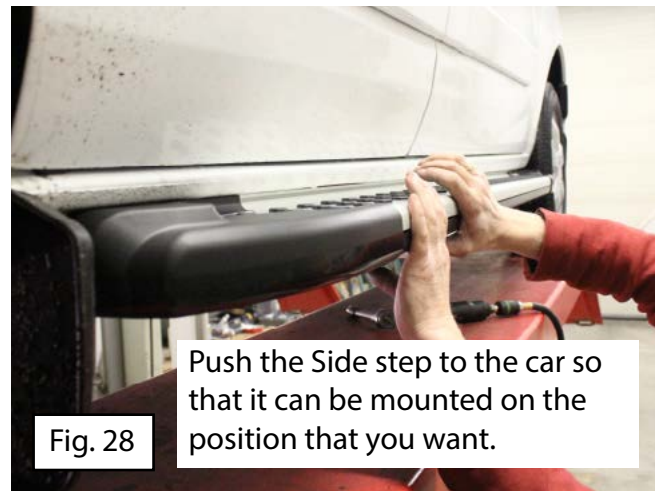

Fig. 28

Push the Side step to the car so that it can be mounted on the position that you want.

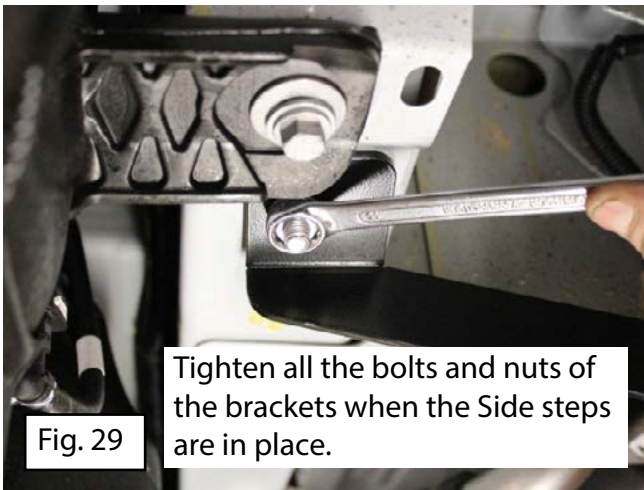

Fig. 29

Tighten all the bolts and nuts of the brackets when the Side steps are in place.

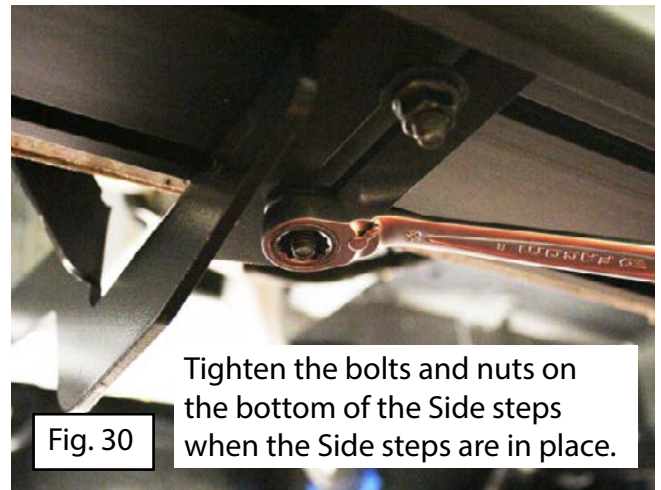

Fig. 30

Tighten the bolts and nuts on the bottom of the Side steps when the Side steps are in place.



Matching accessories:

